

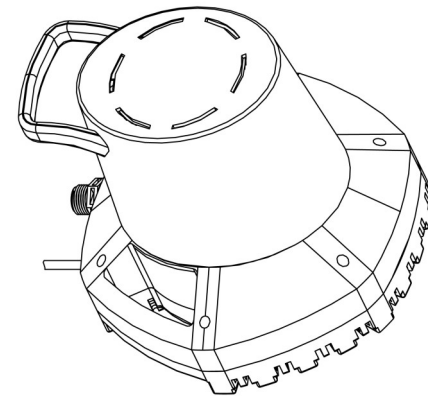



***INSTALLATION & OPERATION  
MANUAL  
SUBMERSIBLE POOL COVER PUMP  
Model: 92395***





## Safety Guidelines

Carefully read, understand and follow all safety instructions in this manual.

 This is the safety alert symbol. When you see this symbol, look for one of the following signal words.

 **DANGER** Indicates a hazardous situation which, if not avoided, will result in death or serious injury.

 **CAUTION** Indicates a hazardous situation which, if not avoided, could result in death or serious injury.

 **WARNING** Indicates a hazardous situation which, if not avoided, could result in minor or moderate injury.

## Safety Information

Read these warnings carefully. Know the application and limitations of this pump. Failure to follow these warnings could result in serious bodily injury and/or property damage.

 **DANGER** RISK OF ELECTRICAL SHOCK. Disconnect and lockout power supply before removing old pump or installing or servicing this pump.

 **DANGER** RISK OF ELECTRICAL SHOCK. Do not use this pump to drain the pool or spa cover if there are people in the water.

 **WARNING** Attach only to grounding type receptacle.

 **WARNING** This pump has been investigated for draining swimming pool and spa covers only.

 **CAUTION** Do not use this pump to pump flammable or explosive fluids such as gasoline, kerosene, etc. Do not use this pump in flammable or explosive environments. Use only with liquids compatible with pump component materials.

 **WARNING** RISK OF ELECTRICAL SHOCK. DO NOT use the power cord to, transport or position the pump. The cord may pull apart exposing bare wires which could cause a fire or electrical shock. Use the handle supplied with the pump for installing, positioning and removing the pump.

 **WARNING** Do not run the pump dry. This pump relies on water for cooling. Running the pump dry can cause the pump to overheat and the possibility of burns to anyone that handles the pump. Running the pump dry will void the warranty.

 **WARNING** Don't expose pump to freezing temperatures as damage to the pump and/or hose can occur.

## LIMITED WARRANTY: POOL COVER PUMP

Superior Pump warrants the products specified in this warranty to be free from defects in material or workmanship for five (5) years from date of purchase. During the time period and subject to the terms and conditions, Superior Pump will repair or replace to the original user or consumer any portion of this product which proves to be defective due to materials or workmanship. At all times Superior Pump shall have and possess the sole right and option to determine whether to repair or replace defective equipment, parts, or components. Superior Pump has the option to inspect any product returned under warranty to confirm that the warranty applies before repair or replacement under warranty is approved. This warranty sets forth Superior Pump's sole obligation and purchaser's exclusive remedy for defective product. Return defective product to the place of purchase for warranty consideration.

### WARRANTY PERIOD - PRODUCTS:

If, within the duration of product use by the original user, this product proves to be defective due to materials or workmanship, the product shall be repaired or replaced at Superior Pump's option, subject to the terms and conditions set forth in this warranty statement. Proof of purchase is required for warranty consideration. In the absence of suitable proof of the purchase date, the effective period of this warranty is 12 months from the product's date of manufacture.

### LABOR, ETC. COSTS:

Superior Pump shall IN NO EVENT be responsible or liable for the cost of field labor or other charges incurred by any customer in removing and/or affixing any product, part, or component thereof.

### PRODUCT IMPROVEMENTS:

Superior Pump reserves the right to change or improve its products or any portions thereof without being obligated to provide such a change or improvement for units sold and/or shipped prior to such change or improvement.

### GENERAL TERMS AND CONDITIONS:

This warranty shall not apply to damage due to acts of God, normal wear and tear, normal maintenance services and the parts used in connection with such service, lightning or conditions beyond the control of Superior Pump, nor shall it apply to products which, in the sole judgment of Superior Pump, have been subject to negligence, abuse, accident, misapplication, tampering, alteration; nor due to improper installation, operation, maintenance or storage; nor to excess of recommended maximums as set forth in the instructions. Warranty will be VOID if any of the following conditions are found:

1. Product is used for purposes other than those for which it was designed and manufactured
2. Product not installed in accordance with applicable codes, ordinances, and good trade practices
3. Product connected to voltage other than indicated on nameplate or labels
4. Pump exposed to but not limited to the following: sand, gravel, cement, grease, plaster, mud, tar, oil, gasoline, solvents or other abrasive or corrosive substances
5. Pump has been used for pumping liquids above 120°F
6. Pump allowed to operate dry (liquid supply cut off)

### DISCLAIMER:

Any oral statements about the product made by the seller, Superior Pump, the representatives, or any other parties do not constitute warranties, shall not be relied upon by the user, and are not part of the contract for sale. Seller's and Superior Pump only obligation, and buyer's only remedy, shall be the replacement and/or repair by Superior Pump of the product as described above. NEITHER SELLER NOR SUPERIOR PUMP SHALL BE LIABLE FOR ANY INJURY, LOSS OR DAMAGE, DIRECT, INCIDENTAL OR CONSEQUENTIAL (INCLUDING, BUT NOT LIMITED TO, INCIDENTAL OR CONSEQUENTIAL DAMAGES FOR LOST PROFITS, LOST SALES, INJURY TO PERSON OR PROPERTY, OR ANY OTHER INCIDENTAL OR CONSEQUENTIAL LOSS), ARISING OUT OF THE USE OR THE INABILITY TO USE THE PRODUCT, AND THE USER AGREES THAT NO OTHER REMEDY SHALL BE AVAILABLE TO IT. Before using, the user shall determine the suitability of the product for his/her intended use, and user assumes all risk and liability whatsoever in connection therewith.

THE WARRANTY AND REMEDY DESCRIBED IN THIS LIMITED WARRANTY IS AN EXCLUSIVE WARRANTY AND REMEDY AND IS IN LIEU OF ANY OTHER WARRANTY OR REMEDY, EXPRESSED OR IMPLIED, WHICH OTHER WARRANTIES AND REMEDIES ARE HEREBY EXPRESSLY EXCLUDED, INCLUDING BUT NOT LIMITED TO ANY IMPLIED WARRANTY OF MERCHANTABILITY OR FITNESS FOR A PARTICULAR PURPOSE, TO THE EXTENT EITHER APPLIES TO A PRODUCT SHALL BE LIMITED IN DURATION TO THE PERIODS OF THE EXPRESSED WARRANTIES GIVEN ABOVE.

Some states and countries do not allow the exclusion or limitations on how long an implied warranty lasts or the exclusion or limitation of incidental or consequential damages, so the above exclusion or limitations may not apply to you. This warranty gives you specific legal rights, and you may also have other rights which vary from state to state.

## Notes

---

---

---

---

---

---

---

---

---

---

---

---

---

---

---

---

---

---

---

---

---

---

---

---

## Safety Information (continued)

**⚠ WARNING** Do not use this pump for potable/drinking water. Use only in applications for which the pump is designed for.

**⚠ WARNING** According to the state of California (Prop 65), this product contains chemicals known to the state of California to cause cancer and birth defects or other reproductive harm.

**⚠ WARNING** DO NOT UNDER ANY CIRCUMSTANCES REMOVE THE GROUND PIN, MODIFY THE CORD OR TRY TO REMOVE THE PLUG. The 3-prong plug must be inserted into a mating 3-prong grounded receptacle. If the installation does not have such a receptacle, it must be changed to the proper type, wired and grounded in accordance with the National Electrical Code and all applicable local codes and ordinances.

**⚠ WARNING** All wiring must be performed by a qualified electrician.

**⚠ WARNING** Keep hands clear of suction & discharge openings. To prevent injury, never insert fingers into pump while it is plugged in.

**⚠ WARNING** Do not handle this pump with wet hands or while standing on wet or damp surfaces or in water.

**⚠ WARNING** This pump is NOT designed for use as a sump, sewage or effluent pump. Do not use this unit to pump sewage or effluents. Never use in hazardous or explosive environments.

**⚠ WARNING** This pump motor is equipped with an automatic resetting thermal protector and may restart unexpectedly.

## Description

This pool cover pump is designed to automatically remove water from pool and spa covers. A float switch is provided for automatic operation and is equipped with a 25', 3- prong power cord.

## Specifications

Model	92395
HP	1/3
Volts	120 volt AC
Amps	3.8 Amps
Hz	60 Hz
Phase	1
Discharge Size	1" NPT or 3/4" GHT with included adapter
Max. Solids Handling	3/16"
Liquid Temperature Range	32°F - 120°F
Cord Length	25'
Switch Type	Vertical
Switch on Level (Factory Set, Adjustable)	2"
Switch off Level (Factory Set, Adjustable)	1-1/2"
Pump Housing Construction	Thermoplastic
Pump Base Construction	Thermoplastic
Impeller	Thermoplastic
Motor Shaft	Stainless Steel
Shaft Seal	Carbon/Ceramic/Stainless Steel
Fasteners	Stainless Steel
Shut off head	26'
Max. PSI	10.8

## Replacement Parts

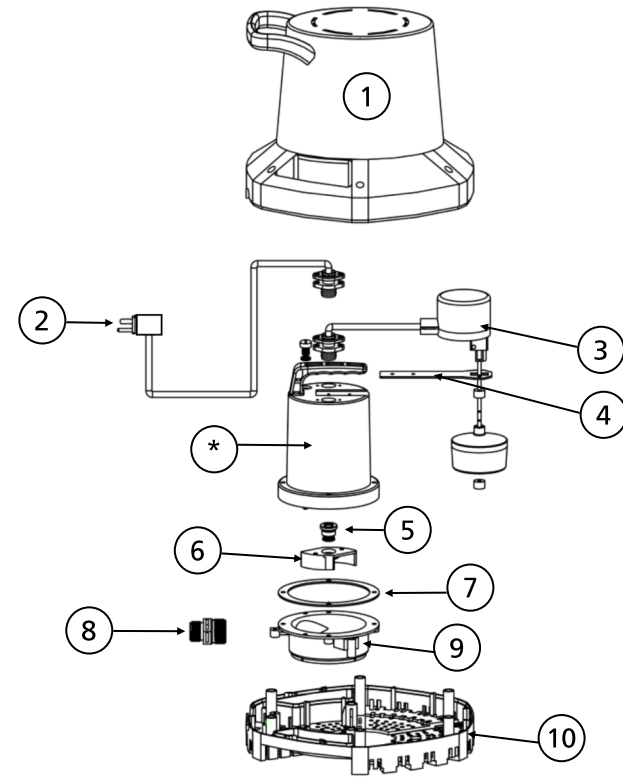

Ref#	Description	92395
1	Outer Pump Cover	99084
2	Power cord	99011
3	Vertical Float Switch (Includes float switch, float rod, float ball and grommets)	92010-PCP
4	Vertical Float Switch Bracket	99154
5	Shaft Seal	99057
6	Impeller	99060
7	Gasket	99085
8	Garden hose adapter (1" NPT x 3/4" GHT)	99063
9	Volute	99086
10	Outer pump base	99083

\*If motor fails, replace entire pump

## Performances

Height and/or piping restriction will reduce the pump output performance. It is recommended to use the same size or larger pipe as the pump discharge for optimum performance.

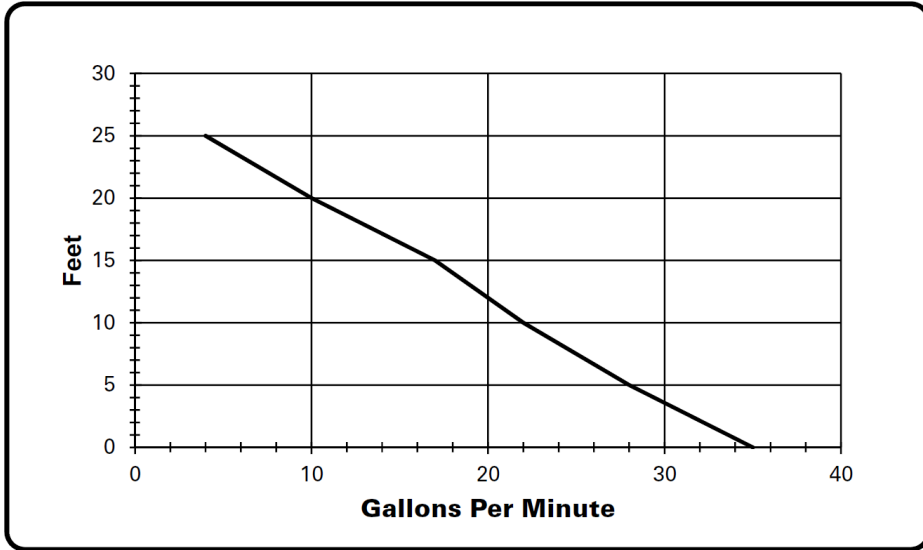

Model	Discharge Height	0'	5'	10'	15'	20'	25'
92395	Gallons Per Minute	35	27	20	17	10	4

## Installation

1. To use this pump with a garden hose, first install the garden hose adapter into the pump discharge. To keep friction loss as low as possible, use a 5/8" or larger garden hose. Use the shortest possible length of hose.
2. If backflow is a problem in your application, the use of a 1" NPT check valve (sold separately) should be used on the pump discharge. This will prevent water from draining back onto the pool or spa cover.
3. Place the pump upright on the cover where water will collect. See Figure 1. Do not place the pump directly in mud, sand or leaves as these materials can clog or cause damage the pump. Do not move or position the pump by the power cord or discharge hose. If necessary, use a length of rope secured to the lower pump handle to position.

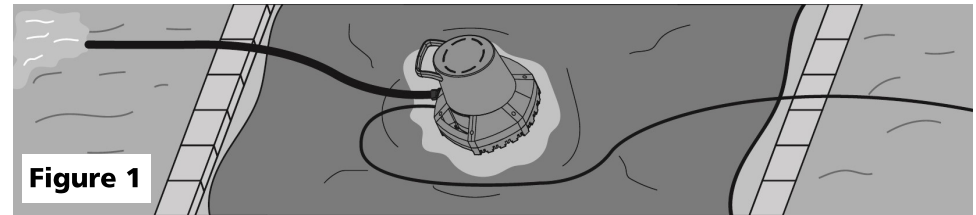

Figure 1

## Operation

1. Plug the pump into a properly grounded 120 volt outlet. If the pump does not turn on, make sure that the circuit breaker for the circuit is in the "ON" position. If the circuit breaker is on and the pump still does not run, consult a licensed electrician. **DO NOT MODIFY THE CORD OR PLUG.** Any modification of the cord and/or plug could cause severe personal injury. It will also void the warranty.
2. The pump will automatically start when the water level reaches approximately 2" and turn off when the water level reaches approximately 1-1/2". The on/off levels can be adjusted by moving the grommets on the float rod up or down. To access the float switch, remove the 6 screws that secure the pump cover to the base. Adjust the rubber grommets on the float rod to your desired level. See Figure 2 on page 6.
3. Do not let the pump run dry. The pump depends on water for cooling and lubrication. Operating the pump without water may cause the motor to overheat or cause damage to internal parts. It may also shorten the life of your pump.
4. The pump motor is thermally protected. It is not recommended for pumping liquids over 120° F (49° C). The thermal overload protector will automatically shut down the pump in an overheat situation. The pump will reset itself once the pump cools down. This overload is designed as a safety device and it will fail after repeated use. Normal operation is for fluids between 32° F & 120° F (0° C - 49° C).

## Airlock

1. This pump is equipped with an anti-airlock hole. A stream of water will emit from this hole when the pump is operating. This is a normal feature of this pump. The anti-airlock hole should be cleaned periodically to prevent the pump from becoming air locked.
2. To clean, remove the 6 screws that secure the outer cover of the pump to the base. The anti-airlock hole is located on the inner pump housing near the discharge port. See Figure 2. Clean with a paper clip or piece of wire.

## Maintenance

**⚠ DANGER** Risk of electric shock. Always disconnect the power supply before attempting to install, service or perform maintenance on the pump.

**⚠ WARNING** All repairs must be made by an authorized service center.

**⚠ CAUTION** This submersible pump contains oil which may become pressurized and hot under normal operating conditions - allow the pump to cool for 2-3 hours before servicing.

1. The pump motor is hermetically sealed in the housing and does not require any service. Disassembly of the motor housing or modification of the power cord voids the warranty.
2. Periodically check the lower base/screen for obstructions. Clean if necessary.
3. Periodically inspect and clean the anti-airlock hole.
4. Inspect the float switch for any accumulated debris that may inhibit it from operating properly. Clean if necessary.
5. Inspect the impeller for signs of wear and obstructions.
6. Inspect the power cord for signs of damage or wear. Do not operate the pump if the cord is damaged or worn.

**Figure 2**

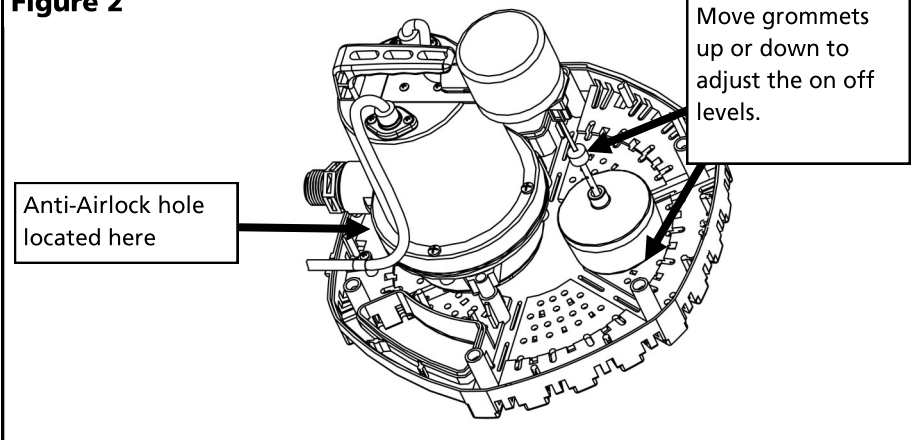

## Troubleshooting

Problem	Possible Causes	How to Correct
If the pump does not start or run	Pump is not plugged in, switch or breaker is turned off	Plug pump in or turn on switch/breaker
	Check for blown fuses or tripped circuit breakers	Replace fuse, reset breaker
	Float switch is defective	Check and replace if necessary
	Motor thermal protector tripped	Allow pump to cool. Pump will reset automatically
The pump starts and stops too often	Float switch is stuck or obstructed	Remove obstruction so the float switch will operate freely
	Backflow of water from discharge hose/pipe	Install or replace check valve
	Float switch needs adjustment	Remove outer cover to access float switch. Adjust on/off level by moving the rubber grommets on the float rod to desired levels.
If the pump runs but moves little or no water	Float switch is defective	Replace float switch
	Clogged discharge hose/pipe	Remove clog
	Frozen discharge hose/pipe	Allow hose/pipe to thaw
	Pump is air locked	Check airlock hole for clogs and clean if necessary
	Low line voltage	Check wire size and increase if necessary
	Clogged intake screen	Clean debris from the screen
Pump does not shut off	Worn, damaged or clogged pump parts	Inspect for wear, damage or clog and clean or replace part if necessary
	Discharge head exceeds pump capacity	See performance chart for pump limitations
	Float switch is obstructed or stuck	Remove obstruction
	Defective Float Switch	Replace float switch